

# OPERATING AND USERS MANUAL



BATTERY CHARGER

## FIRST

12V-10A

12V-15A

12V-25A

12V-40A

24V-20A

# WARNING

FIRST-rev 01



## BEFORE OPERATION

**THIS MANUAL CONTAINS VITAL AND ESSENTIAL INFORMATION. IN ORDER TO AVOID ELECTRICAL SHOCKS OR OTHER DAMAGE, THE OWNER SHOULD READ AND UNDERSTAND THIS IMPORTANT DOCUMENT BEFORE OPERATING THE CHARGER.**

Contact **mdp electronics** if you do not understand a statement.

This device is not intended for use by persons (including children) with physical, sensory or mental disability, or by persons lacking experience or knowledge, unless they have received from a person in charge of their safety adequate supervision or preliminary instructions on how to use the device.



## Before Installation.

- ▶ In order to avoid overcharging or irreversible damage to the materials, please follow closely all recommendations cited below. Do not install this system near inflammable materials. An owner should seek guidance from an authorized DOLPHIN dealer or the factory.
- ▶ Do not install this device near a heat source.
- ▶ It should not be installed in an airtight or badly ventilated area.
- ▶ All ventilation ducts must be unobstructed.
- ▶ Leave at least 10 cms / three inches clearance around the device for proper ventilation.
- ▶ Mount in a vertical position, to create natural ventilation for the charger. Note that the wiring connections are at the bottom of the charger.
- ▶ All electrical connections to and from the charger must remain accessible at all times.

- ▶ This system should not be exposed to water or dust.
- ▶ It is strictly forbidden to tamper with the system casing in any way.
- ▶ This device is not a toy and must be kept out of the reach of children.



### Connecting the Device.

In order to avoid all risk of electric shock or irreversible damage to the device, please follow very carefully the following recommendations

- ▶ This device is set to be connected to a mono-phase network **230V 50Hz or 115V 60Hz (except 10A & 15A)**
- ▶ The installation to which the device is connected must comply with the standards currently enforced in the country of use.
- ▶ In order to protect the occupants, the input point must be attached to a differential circuit breaker. Please refer to the specific characteristics of the circuit breaker.
- ▶ For security reasons, the system's PE terminal must strictly be connected to the installation's Earth (green/yellow wire in the cable section). Please consult the wiring diagram.
- ▶ To prevent overheating, ensure the correct connection and size of cables.
- ▶ The input cable must not exceed 3 meters (10 feet) and the output cable 1.5 meters (5 feet).
- ▶ All cable connections and connectors must be maintained in good condition. Once the connection of the AC cable has been completed it is imperative to fit the Winsta Wago snap on security cover. See "Assembling the Shore Power Connector"

# WARNING

FIRST-rev 01



## **Start up precautions.**

In order to avoid all risk of electric shock or irreversible damage to the device, please follow very carefully the following recommendations.

- ▶ Do not dismantle the device. The housing (protection against fire) must be correctly mounted.
- ▶ This device complies with enforced standards; regarding emitted interference, protection against disturbances of external origins (refer to the paragraph on EMC – Technical Specifications.)
- ▶ When in use, avoid submitting the device to levels of interference, in particular electromagnetic and conducted, superior to those legally permitted (for example, the device installed too close to an emitter) as this may cause irreversible damage.
- ▶ This device emits interference (electromagnetic and conducted) which complies with legal standards. Ensure that materials used are compatible i.e. susceptible, with this device in order to avoid irreversible damage.

## **Series number.**

This reference is found on a grey sticker on the side of the charger. It is made up of: 2 digits indicating the manufacturing year; 09 for 2009, a letter representing the month; C for March, and a 4 or 5 digit number indicating the production number.

Rev XX refers to the number of modifications / evolution of the product since its initial launch.

**NB: Choosing the charging curve.**

It is extremely important to choose the correct charging curve, one which is appropriate for the battery's technology. An incorrect choice could cause irreversible damage.

- ▶ This is particularly true for charging curves where the charging voltage is higher than the manufacturers' recommended voltage levels.
- ▶ There is a high risk of overheating and emission of noxious gases
- ▶ Charging curve 4 is compatible with LiFeSo4 batteries that have a BMS (battery management system) installed.
- ▶ It is essential to consult the battery manufacturer's recommendations.

**Maintenance precautions.**

- ▶ This device cannot be dismantled and thus the PC board is inaccessible. It is strictly forbidden to dismantle the housing for any reason. Electric shock possible.
- ▶ In order to prevent risk of electric shocks during maintenance, please follow closely all recommendations below before any maintenance begins.
- ▶ Any operation carried out to this effect must be carried out by an authorized electrician. In the event of damaged wires or cables, these must be replaced by an authorized electrician. The end user must not attempt to change them.
- ▶ The mains and battery connections must be disconnected before any work is carried out in order to avoid transfer of energy
- ▶ Fuses must be replaced by fuses that have the same characteristics and performance levels.

# WARNING

FIRST-rev 01



	12V 10A	12V 15A	12V 25A	12V 40A	24V 20A
Lead open battery		Battery type: Lead open			
		V.boost = 14,2V V.float = 13,2V		= 28,4V = 26,4V	
Gel, AGM, Spiral battery		Battery type: GEL, AGM, Spiral			
		V.boost = 14,2V V.float = 13,7V		= 28,4 = 27,4	
Lead calcium battery		Battery type: Lead Calcium			
		V.boost = 14,8V V.float = 13,7V		= 29,6 = 27,4	
Power Supply or LiFeSo4 with integrated BMS battery		Battery type: Power supply or LiFeSo4+BMS			
		V.boost = 14,2V V.float = 14,2V		= 28,4 = 28,4	
Weekly Equalization	automatic				
Voltage Allowance	+/- 2%				
Residual wave	< 1% pp (BW < 20 MHz)				
Current	10A	15A	25A	40A	20A
Fuse	F15A 32V Automotive	F20A 32V Automotive	2xF15A 32V Automotive	2xF25A 32V Automotive	2xF15A 32V Automotive
Protections	Against output overload, output short circuit, excessive internal temperature, excessive battery temperature, output overvoltage, battery reverse polarity (fuse)				
<b>General</b>					
Display	Tricoloured LED				
Night mode (Diagram B)	/	/	Button		
Operating temp	-10°C to +50°C / +14°F to +122°F				
Storage temp	-20°C to +70°C / -4°F to +158°F				
Humidity	10% to 90% (without condensation)				
Ventilation	Natural		Forced fan cooling		
EMC	EN61000-6-3 & EN61000-6-1				
Security	EN60335-2-29 (2002)				
Housing	White aluminium – wall mounted				
Mounting	2 x 4mm screws				
Dimensions (mm)	238(h)x120.5(w)x95.6(d)		354(h)x120.5(w)x 95.6(d)		
Weight	1.3 kg / 2.87lbs		1.9 kg / 4.2lbs		
Ac Connection	3 points, 20A 230V, 4mm_max Ref : 770.813/G11-000 (WINSTA - WAGO)				
Battery Connection	4 points, 40A 630V, 10mm_max Ref : PC 6-16/4-G1F-10,16 (PHOENIX CONTACT)				

Diagram A :

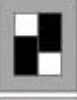
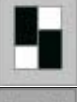

FIRST-rev 01

12V 10A	12V 15A	12V 25A	12V 40A	24V 20A
---------	---------	---------	---------	---------

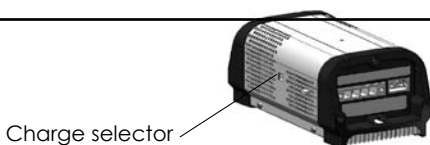



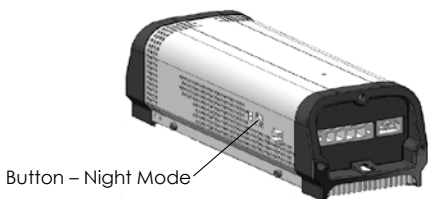

Input				
Tension	230V +/- 15% 115V please consult us		115V - 230V (+/- 15%)	
Frequency	50Hz - 60Hz (+/- 10%)			
Cos phi	0.6 typ		0.9 typ	
Efficiency	80% typ			
Mains consumption	1.3A	1.9A	4A/2A	7A/3.5A
Fusible	T2A 250V 5x20mm	T3, 15A 220V 5x20mm	T6A 250V 5x20mm	T10A 250V 5x20mm
Output				
Nb of outputs	3 isolated outputs			
Nb charging curves	4 possible charging curves. Selection by external dip-switch			
Curves types	IUUo & automatic weekly equalization			
Charging profiles (Diagram A)				

## Diagram B :



# OPERATING INSTRUCTIONS

FIRST-rev 01

<b>CHARGE</b>		ABSORPTION (1)
		EQUALISATION (2)
		END EQUAL. (3)
		FLOATING (4)
<b>FAULT</b>		TEMP (5)
		VOLT OUT (6)
		BAT FUSE (7)

MODE	LED	STATUS
<b>Absorption</b>	Steady yellow (1)	The batteries are charging. Time required to complete Absorption mode varies depending on the initial status of the batteries, but is limited to 6 hours.
<b>Equalisation</b>	Yellow blinking (2)	The batteries are coming to the end of the charging cycle. Time required to complete Equalization mode, depending on the initial status of the batteries, varies from 30 minutes to 4 hours.
<b>End of Equalisation</b>	Green blinking (3)	The batteries are almost charged. Floating mode will begin in less than 30 minutes.
<b>Floating</b>	Green (4)	The batteries are completely charged.
<b>Internal Temperature fault</b>	Red fixed (5)	The charger is on Standby for a period of between 30 seconds and 10 minutes. Once the fault has been solved, the device will start up again automatically. ▶ <i>If this problem arises, please check the external temperature as well as the internal fan and the space around the charger.</i>
<b>Output voltage fault</b>	Red blinking (6)	The charger is on Standby for a period of 30 seconds. Once the fault has been solved, the device will start up again automatically. ▶ <i>In reality, the PC Board has probably failed and the damage is irreversible.</i>
<b>Battery fuse fault</b>	Red Flashing (7)	The fuse should be replaced. ▶ <i>Please check all connections as well as the battery's polarity and status</i>
<b>"Night" Mode</b> 12V-25A 12V-40A 24V-20A	-	This mode allows the charger to work without noise (from the fan). In this case, charging levels adapt. To activate this mode, press the button for about 2 seconds. To deactivate, a simple press of the button or the mode deactivates automatically after 10 hours.



FIRST-rev 01

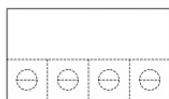
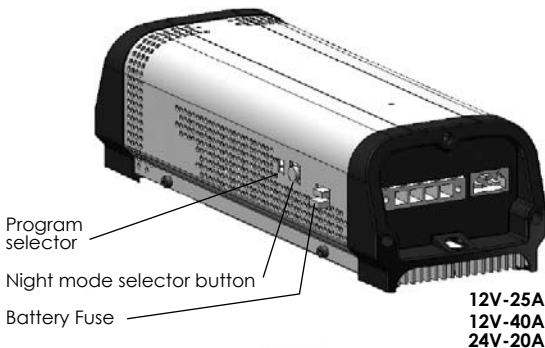
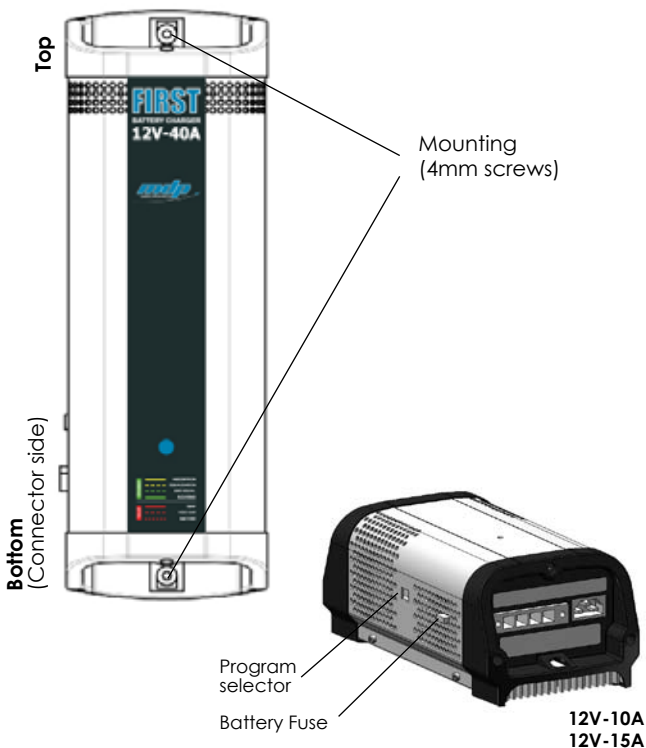

**Recommended cable size**

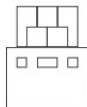

**Recommended cable size**

12V10A : 2.5 mm<sup>2</sup> / 12 AWG  
 12V15A : 2.5 mm<sup>2</sup> / 12 AWG  
 12V25A : 4.0mm<sup>2</sup> / 10 AWG  
 12V40A : 6.0 mm<sup>2</sup> / 8 AWG

12V10A : 3 x 0.75 mm<sup>2</sup> / 18 AWG  
 12V15A : 3 x 0.75 mm<sup>2</sup> / 18 AWG  
 12V25A : 3 x 1.5 mm<sup>2</sup> / 14 AWG  
 12V40A : 3 x 1.5 mm<sup>2</sup> / 14 AWG

Lg cables : 1.5 m / 4.9 feet max    Lg cables : 3 m / 9.8 feet max  
 Cable type: according to local regulations

# CONNECTION

FIRST-rev 01

## Wiring diagram

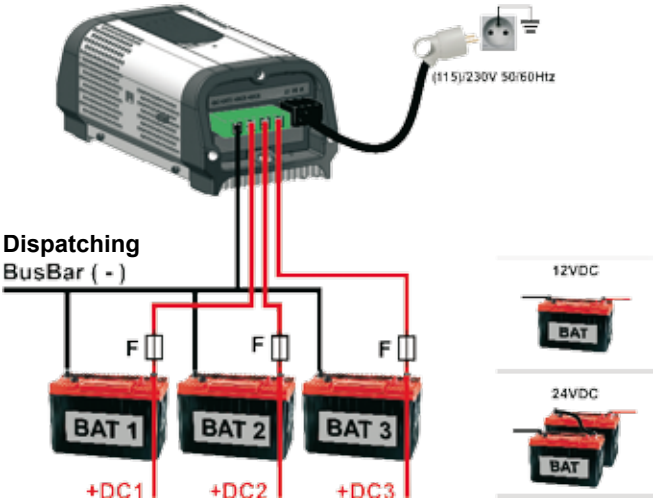

## Assembling the shore power connector



### ◀STEP 1:

Remove approx 2 cm of the outer sheath  
Remove approx 8 mm of the inner wires' sheaths  
Tinplate the bare copper ends



### ◀STEP 2:

Remove the security cap using an utility knife

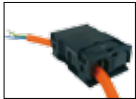

### ◀STEP 3:

Pull the conductor through the pre latched strain relief housing



### ◀STEP 4:

Open the clamp with a screwdriver and insert the first cable up to the stop. Repeat this step for all three cables.



### ◀STEP 5:

Latch the connector on to the strain relief housing.



### ◀STEP 6:

Snap together the upper and lower parts of the strain relief housing and tighten it using the screw.

FIRST-rev 01

## Dimensions 12V-10A / 12V-15A.

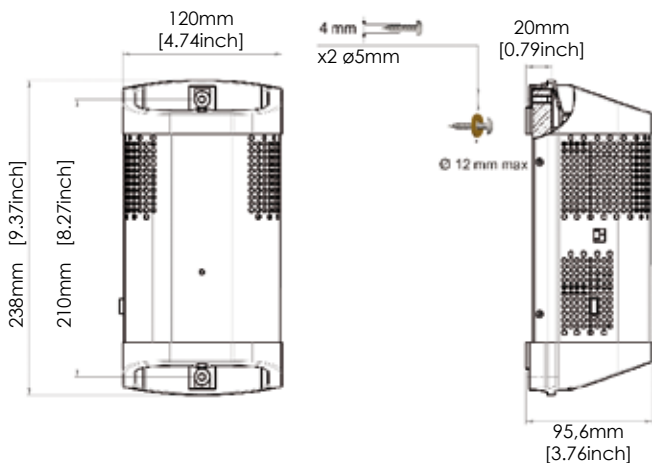

## Dimensions 12V-25A / 12V-40A / 24V-20A

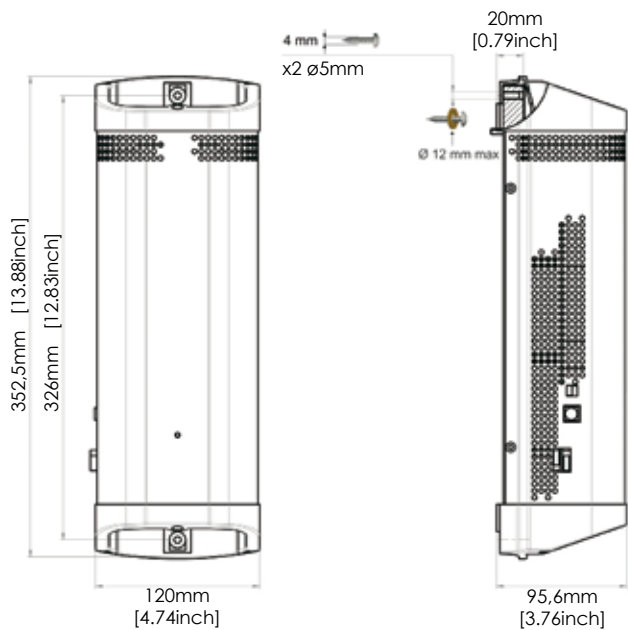

# WARRANTY

FIRST-rev 01

**IN ORDER TO PREVENT ALL RISKS ARISING DUE TO THE INCORRECT USE OF THIS DEVICE, PLEASE CAREFULLY READ THE LIST OF POSSIBLE SITUATIONS OR FAULTS THAT ARE NOT COVERED BY THE WARRANTY.**

▶ If the mechanical components of the device are not protected by the casing and fall, irreversible damage of the ventilation system and certain electrical components may result.

▶ Modifications made to the casing (and in particular if holes are bored), may result in the deposit of metallic shavings or filings onto the electronic card and consequently may cause the malfunction of or damage to the device.

▶ Interfering with or modifications made to the PC Board may result in unforeseen operations and consequently may cause the malfunction of or damage to the device.

▶ Use of a non-adapted power supply (as a general rule, the input voltage will be too high) may cause the malfunction of or damage to the device.

▶ Over voltage from the mains or a lightning strike will usually cause irreversible damage to the PC Board.

▶ Replacement of battery fuses with fuse types other than those recommended (same characteristics) may cause the malfunction of or damage to the device.

▶ Obvious connection errors will result in the malfunction of or damage to the device.

▶ Water gaining access to the interior of the device may cause the malfunction of or damage to the device.

FIRST-rev 01

## **NB: Choosing the charging curve.**

It is extremely important to choose the correct charging curve one which is appropriate for the battery technology. An incorrect choice could cause irreversible damage.

- ▶ This is particularly true for charging curves where the charging voltage is higher than the manufacturers' recommended voltage levels.
- ▶ There is a high risk of overheating and emission of noxious gases
- ▶ Charging curve 4 is compatible with LiFeSo4 batteries that have a BMS (battery management system) installed.
- ▶ It is essential to consult the battery manufacturer's recommendations.

## **Disposal.**

This device contains electronic components & material that must be recycled once the device is obsolete.

All obsolete electronic devices must be returned to a local distributor or to a specialized company for an environmentally friendly disposal.

---

## **CE CONFORMITY**

This product conforms to current European standards and has a CE mark. Please consult us for the certificate of conformity.

For further information or assistance,  
please contact:

***mdp electronics***

144 route des Vernes

74370 Pringy

FRANCE

Tél : (33) 0 450 272 030

Fax : (33) 0 450 272 774

e-mail : [contact@mdpelectronics.fr](mailto:contact@mdpelectronics.fr)

**[www.mdpelectronics.fr](http://www.mdpelectronics.fr)**